

HDZP30XD4

30x Zoom IR PTZ WDR Dome Camera









HD

| CAMERA | |
|--------------------------|--|
| VIDEO STANDARD | NTSC/PAL |
| SCANNING SYSTEM | Progressive scan |
| IMAGE SENSOR | 1/3" 4 MP CMOS |
| NUMBER OF PIXELS (H × V) | 2592x1520 |
| MINIMUM ILLUMINATION | 0.05 lux colour @ F1.6, 0 lux B/W with IR LEDs on @ F1.6 |
| S/N RATIO | > 55 dB |
| ELECTRONIC SHUTTER SPEED | 1/3 – 1/300,000 s |
| RESOLUTION | 4 MP (2592x1520) |
| IR DISTANCE | Up to 328 ft. (100 m), depending on scene reflectance |
| NUMBER OF IR LEDs | 4 IR LEDs |
| DAY/NIGHT | Auto (ICR)/Colour/B&W |
| BACKLIGHT COMPENSATION | BLC/HLC/WDR (120dB) |
| WHITE BALANCE | Auto/ATW/Indoor/Outdoor/Manual |
| GAIN CONTROL | Auto/Manual |
| WIDE DYNAMIC RANGE | WDR |
| NOISE REDUCTION | Ultra DNR (2D/3D) |
| LENS | 4.5 – 135 mm, MFZ, F1.6 |
| HORIZONTAL ANGLE OF VIEW | 60° ~ 2.2° |
| OPTICAL ZOOM | 30x |
| DIGITAL ZOOM | 16x |
| CLOSE FOCUS DISTANCE | 100 mm – 1000 mm |
| FOCUS CONTROL | Auto/Manual |
| OPERATION | |
| PAN/TILT RANGE | Pan: 0°~360° endless; Tilt: 15°~90° |
| AUTO FLIP | 180° |
| MANUAL CONTROL SPEED | Pan: 0.1°~300°/s; Tilt: 0.1°~200°/s |
| PRESET SPEED | Pan: 400°/s; Tilt: 200°/s |
| PRESETS | 300 |
| PTZ MODE | 5 Pattern; 8 Tour; Auto Pan; Auto Scan |
| SPEED SETUP | Human-oriented focal length/speed adaptation |
| POWER UP ACTION | Auto restore to previous PTZ and lens status after power failure |
| PRIVACY MASKING | Up to 24 configurable areas |
| AUDIO | N/A |

| ELECTRICAL | |
|-----------------------|---|
| POWER SUPPLY | 24 VAC/3A ±10% |
| AC FREQUENCY | 50/60 Hz |
| POWER CONSUMPTION | 13 W max. (23 W with IR LEDs on) |
| MECHANICAL | |
| DIMENSIONS | Ø 186.0 mm × 309.0 mm (Ø7.3" × 12.2") |
| PRODUCT WEIGHT | 3.5 kg (7.7 lb.) |
| PACKAGE WEIGHT | 6.8 kg (15.0 lb.) |
| CONSTRUCTION | Die-cast Aluminum |
| CONSTRUCTION COLOUR | RAL 9003 (White) |
| CONNECTIONS | |
| ALARM INPUT/OUTPUT | 2/1 |
| VIDEO OUTPUT | 1-channel BNC high definition video output |
| VIDEO INTERFACE | 1 |
| AUDIO INTERFACE | 1 channel in |
| RS-485 | 1 |
| ENVIRONMENTAL | |
| OPERATING TEMPERATURE | -40°C to 70°C (-40°F to 158°F) |
| RELATIVE HUMIDITY | Less than 90% RH |
| INGRESS PROTECTION | IP66 |
| IP SPECIFICATIONS | |
| PROTOCOL | Pelco-P/D (Auto recognition) |
| RESOLUTION | 4 MP (2592x1520)/1080p(1920x1080)/720p(1280x720) |
| FRAME RATE | 25/30 fps @ 4 MP/1080p; 25/30/50/60 fps @ 720p |
| REGULATORY | |
| EMISSIONS | EN55032, ANSI C63.4-2014 |
| IMMUNITY | CE EN50130-4 |
| SAFETY | UL60950-1; EN60950-1 |
| ROHS | EN 50581 |

30x Zoom IR PTZ WDR Dome Cameras

RECOMMENDED ACCESSORIES

| SYSTEM COMPATIBILITY | | HOUSING AND MOUNTS | |
|----------------------------|---|--------------------|--|
| HRHT404* HQA DVRs | 4 MP, 4-channel, 4 MP@15 fps, 1080p@30/25 fps, 1 SATA, Hybrid HQA DVRs | HDZPMA |  Pole Mount Adapter |
| HRHT408* HQA DVRs | 4 MP, 8-channel, 4 MP@15 fps, 1080p@30/25 fps, 2 SATA, Hybrid HQA DVRs | HDZCMA |  Corner Mount Adapter |
| HRHT416* HQA DVRs | 4 MP, 16-channel, 4 MP@15 fps, 1080p@30/25 fps, 2 SATA, Hybrid HQA DVRs | HDZGM |  Gooseneck Mount (Included with Camera with 1.5" MPT Adapter) |
| HRHQ104* HQA DVRs** | 4-channel, 720p@120/100 fps, 1080p@60/50 fps, 1 SATA, alarm I/O, Hybrid HQA DVRs | HDZCM1 |  PTZ Ceiling Mount |
| HRHQ108* HQA DVRs** | 8-channel, 720p@240/200 fps, 1080p@120/100 fps, 2 SATA, alarm I/O, Hybrid HQA DVRs | HDZJB |  Junction Box |
| HRHQ116* HQA DVRs** | 16-channel, 720p@480/400 fps, 1080p@240/200 fps, 2 SATA, alarm I/O, Hybrid HQA DVRs | HDZBSPA |  1.5" MPT Mount Adapter |

* Pre-installed storage (TB).

** Change the HDZP30XDP4 video output to 1080p before using it with HRHQ DVRs.

DIMENSIONS

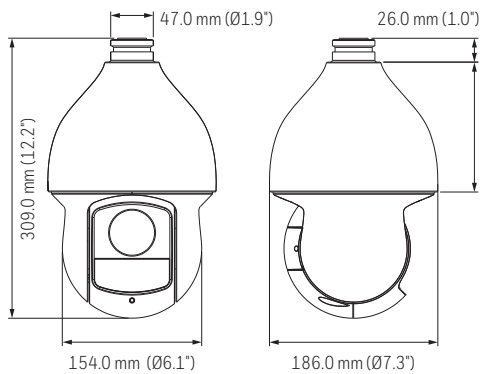

ORDERING

HDZP30XDP4

TDN IR PTZ Dome Camera, 4 MP Resolution, 30x Zoom, 1/3\" 4 MP CMOS, 4.5-135 mm Lens, 4 IR LEDs, 24 VAC, IP66, WDR

For more information

www.honeywell.com/security

Honeywell Security and Fire

Aston Fields Road
Whitehouse Industrial Estate
Runcorn, Cheshire, WA7 3DL
United Kingdom
Tel: +44 (0)8448 000 235
www.honeywell.com

Honeywell Security Office -

Emaar Business Park, Sheikh Zayed Road
Building No. 2, 2nd floor, 201
Post Office Box 232362
Dubai, United Arab Emirates
Tel: +971 44541704
www.honeywell.com

Honeywell reserves the right, without notification, to make changes in product design or specifications.

HSFV-HDZP30XD4-02-UK(O218)DS-Z
December 2018
© 2018 Honeywell International Inc.

Honeywell